



Alfa Laval ThinkTop® V50

Sensing and control

Introduction

ThinkTop V50 takes valve control to a new level and all these new features are available on any Alfa Laval diaphragm, butterfly & single seat. While helping to increase production performance and secure traceability, ThinkTop V50 provide real-time information on the valve's operating status 24/7.

ThinkTop V50 are interchangeable with prior ThinkTop versions, and the appropriate variant is selected based on the number of solenoid valves. With only one sensor target and included adapter, ThinkTop V50 are easily retrofittable to existing Alfa Laval valves.

ThinkTop V50 come fitted with features such as Auto Setup, Live Setup and Flex Setup that streamline the setup process, making it quick and easy. Auto Setup and Live Setup recognise the valve based on its DNA profile and can complete the valve setup without any manual interaction.

Pulse seat clean function available on ThinkTop V50. This valve position-based function controls the optimum seat clean sequence of the valve, making it possible to save CIP time and achieve up to 95% CIP liquid savings for each seat clean.

Application

ThinkTop V50 are designed for use in the dairy, food, beverage, and biopharma industries.

Benefits

- Auto setup
- Automatic valve recognition
- Automatic selection of tolerance band
- Fast, Live and Flex Setup
- 360-degree LED indication
- Pulse seat clean
- Exchangeable (threaded) air-fittings
- Interchangeable with ThinkTop classics

Certificates

A selection of the essential certificates available on ThinkTop



Working principles

The control unit offers a single sensor solution for diaphragm, butterfly, single-seat valves and it can be fitted with 0 or 1 solenoid valves. ThinkTop converts the electrical PLC output signals into mechanical energy to energise, or de-energise, the air-operated valve, using the physical sensor target mounted on the valve stem.

Installation with Auto Setup or Live Setup is intuitive and fast. To initiate Auto Setup, simply press the "SELECT" button and then the "ENTER" button to begin the setup sequence. The ThinkTop automatically recognizes the type of valve and completes the programming sequence fast and efficiently.

Alternatively, the ThinkTop can be set up, without dismantling the control head, using the built-in Live Setup feature for remote-configuration.

Dimensions

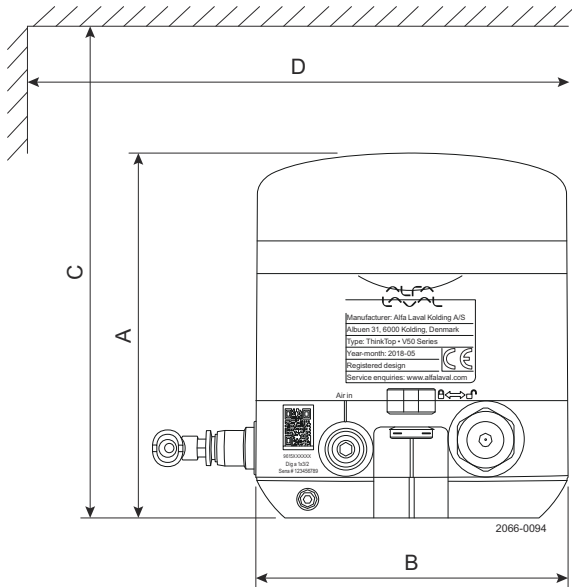

Figure 1. ThinkTop V 50

ThinkTop V 50		
	mm	Inch
A	123	4.84
B	105	4.13
C	200	7.87
D	150	5.91

TECHNICAL DATA

Material

Plastic parts	Nylon PA 12
Steel parts	1.4301 / 304
Gaskets	Nitril / NBR
Air fittings	Nickel plated / Nylon PA6
M12 chassis connector	Stainless steel / Gold plated pins

Environment

Working temperature	
Protection class (IP)	IP69K
Protection class (NEMA)	4, 4X and 6
Hazardous area	ATEX and IECEx in preparation

Control board

Communication	See interfaces section
Sensor accuracy	
V50 – Valve stem length	
Mean Time To Failure (MTTF)	224 years
Approvals	UL/CSA Certificate: E174191

Solenoid valve

Supply voltage	24 VDC \pm 10%
Nominal power	0.3 W
Air supply	300-800 kPa (3-8 bar)
Type of solenoids	3/2-ways
Number of solenoids	0-3
Manual hold override	Yes
Air quality	Class 3,3,3 acc. DIN ISO 8573-1
Air pressure	6-8 bar
B10 data	5 million cycles
Recommendation	Operate once a month to prevent dry-out



Note!

Throughout this leaflet, SV is used as an abbreviation for a solenoid valve

Air fitting	
Threaded air fitting G1/8	ø6 mm (Rim blue) or 1/4" (Rim Grey)
Elbow push-in fittings	ø6 mm (Rim blue) or 1/4" (Rim Grey)

Cable connection	
Main cable gland entry Digital	M16 (ø4 - ø10 mm ²) (0.16" - 0.39")
Main cable gland entry AS-I	M16 (ø2 - ø7 mm ²) (0.08" - 0.28")
Seat lift sensor cable gland entry	M12 (ø3.5 - ø7 mm ²) (0.14" - 0.28")
Max wire diameter	0.75 mm ² (AWG20)

M12 chassis connector	
AS-Interface V50	2 wire, 4-pin series
IO-Link interface V50	3 wire, 4-pin series
Digital interface V50	6 wire, 8-pin series

Vibration	
Vibration	18 Hz-1kHz @ 7.54g RMS
Shock	100g

Humidity	
Constant humidity	
Cyclic humidity	
Working	93% R.H.

Accessories by functionality	
Upper seat lift surveillance	Kit
Valve "opening" speed reduction	0-100%. Outlet air fitting on ThinkTop
Valve "closing" speed reduction	0-100%. Inlet air fitting on actuator
Valve closing speed increase	

OPERATIONAL DATA

ThinkTop LED indication

ThinkTop features a 360-degree light guide. When the sensor target is within the respective setup position band, the corresponding colour lights up.

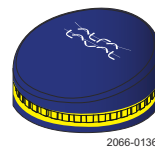
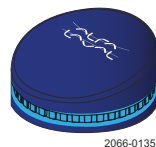
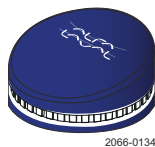
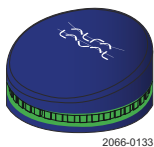

Valve position						
	Actuator	All De-energised	Main valve open Energised	Upper seat lift Energised	Lower seat push Energised	Between
ThinkTop Mode	Factory setting	Green flashing	White flashing	Blue flashing	Yellow flashing	Off
	Operation	Green	White	Blue	Yellow	Off
	Not OK	Green/red flashing	White/red flashing	Blue/red flashing	Yellow/red flashing	Red flashing

Auto and Live setup

Auto Setup is a rule-based function. If one of these rules are not present, Flex Setup must be used.

By default, ThinkTop V50 uses the de-Energised/Energised paradigm for valve positions feedback.

Parameter	Auto Setup/Live Setup	Flex Setup (retrofit mode)
Status feedback (OK or error)	Valve state (Fail safe signal)	Status error
Seat cleaning function	Enabled	Disabled
Valve operation monitor	Enabled	Disabled
Ext. sensor operation monitor	Enabled	Disabled
Interlock	Enabled	Disabled
Output (AS-i master input)	Special	Special
External sensor masking	Enabled	Disabled



Note!

The "Fail safe signal" is always high for idle operation of ThinkTop and the valve

Valve compatibility chart

Use Anytime configurator for correct selection of ThinkTop V50 and V70 on different valve size and types

	Common applications (Auto / Live Setup)	Special applications (Flex Setup)	Incompatible valves
ThinkTop V50	<ul style="list-style-type: none"> Single Seat valves Small Single Seat valve Butterfly valves Diaphragm valves Ball valves Shutter valves Double seat valves Double seal valve 	<ul style="list-style-type: none"> ThinkTop classic retrofit mode or alternative setup with no restrictions Feedback structure such as the open/closed valve feedback All SSV (1/2" - 4") NO, shut off, maintainable, need to be setup as a rotary valve Application with no solenoid valve, feedback indication only One control unit to control multiple valves-actuators SMP-BC where using 2 solenoid valves to operate main valve and pilot leak-detect valves independently 	<ul style="list-style-type: none"> Valves without actuator stem and mushrooms Koltek Type 633 three position actuator, valve size 1" - 3" Regulating valves Safety valves Sample valves SMP-EC 700 series Other valve brands

Overview of control board V50

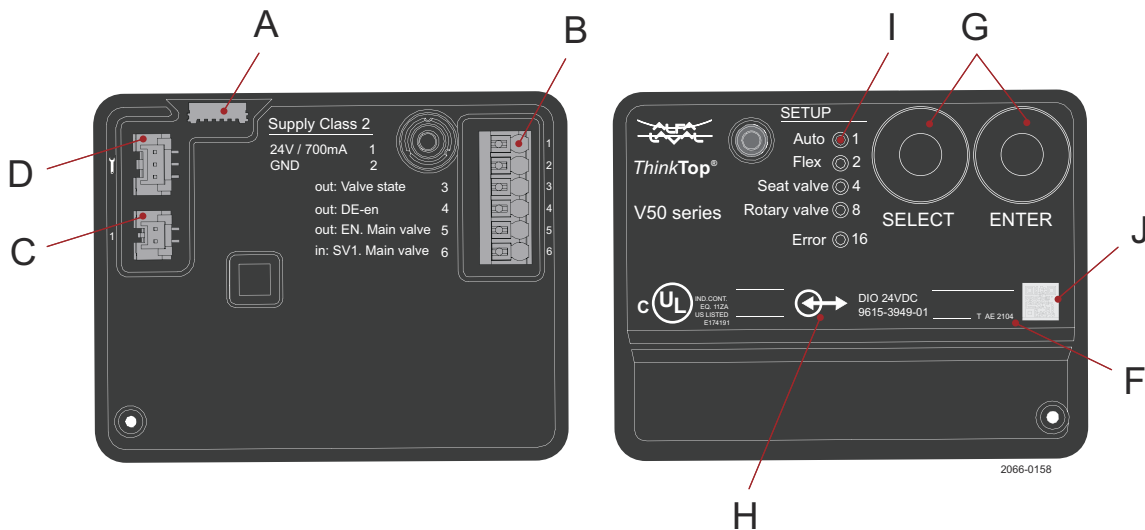

- A: LED indication lamp
- B: Spring loaded terminals
- C: Solenoid valve connectors
- D: Diagnostic port (Alfa Laval)
- E: Upper seat lift sensor terminal
- F: Control board - Firmware version
- G: Push buttons "Select" and "Enter"
- H: Symbol for electrical interface
- I: LEDs for unit status display
- J: Non-public QR code

ThinkTop and automated valve-seat cleaning

The standard features Burst seat clean and Pulse seat clean makes it easy to optimize the water consumption during CIP cleaning of the gaskets in Mixproof valves and drain valves.

Information on how to handle pulse seat clean and burst seat clean can be found in the instruction manual, AS-Interface table and in the IO-Link IODD interface description.

Feature availability table

This table shows in which ThinkTop configurations the features are available and if they can be controlled from the PLC.

ThinkTop	Interface	Feature	Availability
V50	Digital	Pulse clean	Feature not available
V50	AS-Interface	Pulse clean	1 solenoid valve - PLC controlled function
V50	IO-Link	Pulse clean	1 solenoid valve – PLC controlled function

ThinkTop pulse seat clean

Intended for high CIP flow pressure and for single seat valves or butterfly valves used as drain valves. No setup required, pulse seat clean is a standard and ready to perform feature in ThinkTop V50 with one solenoid valve.

How to PLC control the pulse cleaning function, please set up and follow the function diagram. The PLC input duration (a) to the ThinkTop must be at least 500 ms.

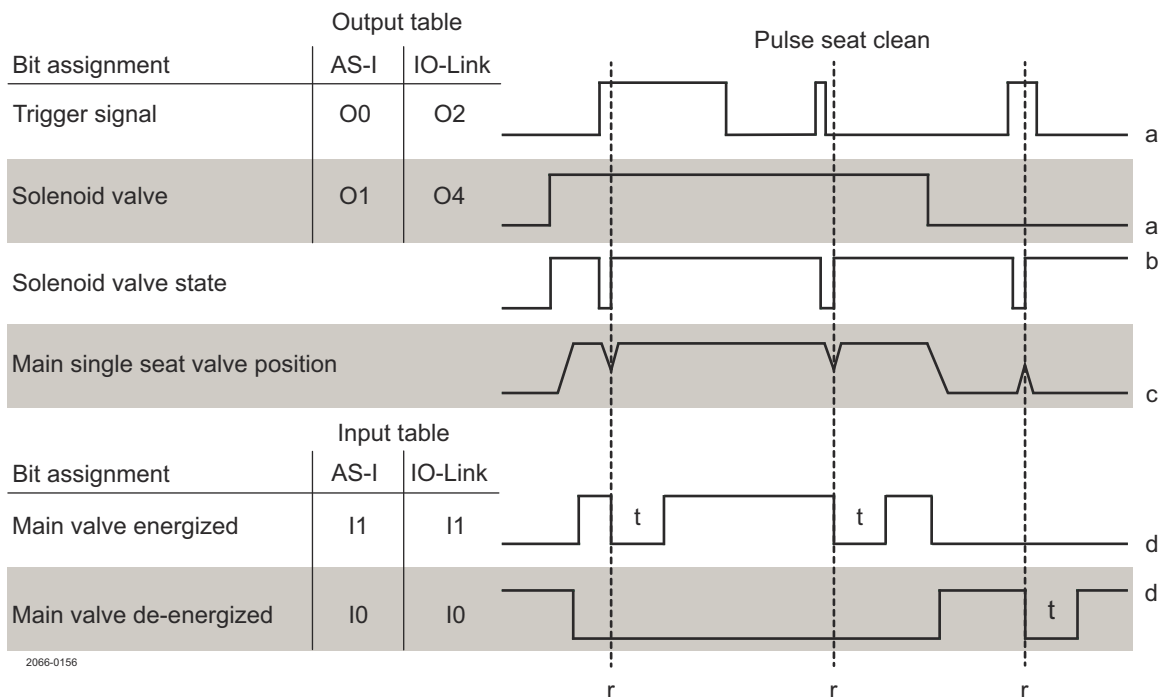

a: Electrical signal from PLC

b: Air output from ThinkTop

c: Physical valve movement

d: Visual LED and electrical signal to PLC

r: Valve position reached

t: 2 sec.

When the valve-position is reached, the pulse seat clean function is released, and the valve returns to the starting position. After which then ready again after 2 seconds to perform another pulse seat clean. A two-second (t) electrical signal and visual feedback (d) is provided as a handshake for successful completion of a pulse seat clean.

Pulse water consumption graph

ThinkTop V50 CIP water consumption during pulse seat clean on different sizes of drain valves, provided with air pressure to the actuator:

Compatible valve actuators

List of compatible valve actuators where pulse seat clean and burst seat clean can be applied:

ThinkTop V50	Valve actuators	Applicable
Pulse seat clean	i-Series	Yes
	Single Seat Valves	Yes
	Butterfly Valves - LKLA-T ø85	Yes
	Butterfly Valves - LKLA-T ø133	No
	Diaphragm valves	No
	Ball valves	No
	Shutter valves	No
	Small Single Seat Valves	No
	Safety and Sample valves	No

Valve state – Fail safe signal

The following table gives an overview of behaviour per Error condition where the valve state signal goes low. Further description of the various Error conditions can be found in the ThinkTop Instruction Manual, section 5,2

Valve state is a decentralized functionality, available for all ThinkTop variants and a feature that can be used for monitoring process issues or to ease and simplify the PLC programming of a valve surveillance.

Error Code #	Error description	ThinkTop Digital Valve state	ThinkTop AS-Interface Valve state not available	ThinkTop IO-Link Valve state
		Main valve FAIL SAFE SIGNAL DE-ENERGIZED SIGNAL behaviour	Main valve not available DE-ENERGIZED SIGNAL behaviour	Main valve FAIL SAFE SIGNAL DE-ENERGIZED SIGNAL behaviour
15	Key lock active	na	na	na
16	Sensor target missing	Drops low	Drops low	Drops low
17	Setup prerequisite issue Missing peripherals	Not connected	Not connected	Not connected
18	Pneumatic part issue	Not connected	Not connected	Not connected
19	Seat lift sensor issue	Drops low	Drops low	Drops low
20	Position not reached	Drops low	Drops low	Drops low
21	Unexpected valve movement	Drops low	Drops low	Drops low
22	Seat-lift sensor missing	Drops low	Drops low	Drops low
23	Solenoid valve 1 missing	Drops low	Not connected	Drops low
24	Solenoid valve 2 missing	Drops low	Not connected	Drops low
25	Solenoid valve 3 missing	Drops low	Not connected	Drops low
26	Interlock warning	Drops low	Not connected	Drops low
27	Output short circuit (Digital)	Drops low	Not connected	Not connected
28	Setup aborted	Not connected	Not connected	Not connected
29	Blocked button	Drops low	Not connected	Drops low
30	Voltage Low (Digital)	Drops low	Not connected	Not connected
30	Communication failure (IO-Link)	Not connected	Not connected	Drops low
31	Safety stop	Drops low	Drops low	Drops low
32 ¹	Pressure shock event	Not connected	Not connected	Not connected

¹ This event is not treated as an error

Default bitmapping

The default settings apply to both Digital, AS-Interface and IO-Link

ThinkTop V50 truth signal table: default factory setting

	DE-EN (I0) close	MAIN (I1) open	Valve state (Fail safe signal)
DE-EN (No active SV)	1	0	1
MAIN SV1 active (O1)	0	1	1

Digital interface

ThinkTop Digital 24V DC

Device name	ThinkTop V50 24V Digital - PNP
Voltage supply	<ul style="list-style-type: none"> 24 VDC \pm 10%; according to EN 61131-2
Protection	<ul style="list-style-type: none"> Reverse polarity (24 VDC \pm 10%); EN 61131-2 Voltage interruption and brown-out; EN61131 Short circuit; EN 61131
Current consumption	<ul style="list-style-type: none"> Nominal 30mA (idle)
Outputs to PLC	<ul style="list-style-type: none"> Max 100mA (solenoid valve and seat lift sensor active)
PLC input card	<ul style="list-style-type: none"> Max rated 24V/100 mA
UL supply	<ul style="list-style-type: none"> Class 2 according to cULus
Voltage-drop	<ul style="list-style-type: none"> Typical 3V at 50 mA
Terminal type	<ul style="list-style-type: none"> Spring force push-in technology Supports nominal wire cross-section between 1.0 mm² [17AWG] and 0.30 mm² [22AWG] Supports wire and ferrules for wire cross-section of 0.75 mm² [18AWG] with pin length 12 mm

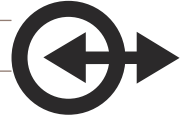

Electrical connections

ThinkTop V50

Terminals	Control board	Colour code wires
1	24V	BN (brown)
2	GND	BU (blue)
3	out: Status	WH (white)
4	out: DE-EN	BK (black)
5	out: EN. Main valve	GY (grey)
6	in: SV1. Main valve	PK (pink)

ThinkTop V50

M12 option (8-pin A-coded plug)

Pin numbers and terminal numbers are aligned

M12 Chassis plug connector	Control board Terminal numbers	M12 pin numbers wire colors
	Solenoid valve	0 or 1x3/2-way
	1: 24V	Pin 1: BN (brown)
	2: GND ¹	Pin 3: BU (blue)
	3: out: Valve state (Valve state) ¹	Pin 2: WH (white)
	4: out: DE-EN	Pin 4: BK (black)
	5: out: EN. Main valve	Pin 5: GY (grey)
	6: in: SV1. Main valve	Pin 6: PK (pink)
	7: nc	-
8: nc	-	

¹ Please be mindful of the difference between the number sequence of the control board terminal and the M12 plug pins

ThinkTop AS-Interface

Device name	ThinkTop V50 ASI2 & ThinkTop V50 ASI3
Supply voltage	<ul style="list-style-type: none"> AS-Interface 29.5 – 31.6 VDC
Protection	<ul style="list-style-type: none"> Reverse polarity (24 VDC \pm 10%); EN 61131-2 Voltage interruption and brown-out; EN 61131 Short circuit; EN 61131
Current consumption	<ul style="list-style-type: none"> Nominal: 30 mA (idle) Max 100 mA (solenoid valve and seat lift sensor active)
Terminal type	<ul style="list-style-type: none"> Spring force push-in technology Supports nominal wire cross-section between 1.0 mm² [17AWG] and 0.30 mm² [22AWG] Supports wire and ferrules for wire cross-section of 0.75 mm² [18AWG] with pin length 12 mm
AS-I specification v2.11	<ul style="list-style-type: none"> Supports standard addressing and are compatible with M0-M4 AS-I master profiles, allows up to 31 nodes on an AS-I network Slave profile = 7FFF
AS-I specification v3.0	<ul style="list-style-type: none"> Supports extended A/B addressing and is compatible with M4 AS-I master profile, allows up to 62 nodes on an AS-I network Slave profile = 7A77
AS-I addressing	<ul style="list-style-type: none"> Default slave address (Node) is = 0 Address (Node) changes with a standard handheld AS-I addressing device or via AS-I Master Gateway



AS-Interface bit table

For the AS-Interface versions, the following bit assignment will be used

PLC system / Gateway Output table	ThinkTop V50
Pulse clean trigger (1 solenoid valve)	O0
SV1. Main valve	O1
SV2. Upper seat lift	nc
SV3. Lower seat push	nc

PLC system / Gateway Input table	ThinkTop V50
DE-EN	I0
EN. Main valve	I1
Upper seat lift	nc
Lower seat push	nc

Electrical connections

ThinkTop V50

Terminal	Control board	Colour code wires
1	AS-i +	BN (brown)
2	AS-i -	BU (blue)

ThinkTop V50

M12 option (4-pin A-coded plug)

Pin numbers and terminal numbers are aligned

M12 Chassis plug connector	Control board Terminal numbers Functions	M12 pin assignments wire colours
<p>20610004</p>	1: AS-i +	Pin 1: BN (brown)
	2: nc	-
	3: AS-i -	Pin 3: BU (blue)
	4: nc	-

IO-Link interface

ThinkTop IO-Link

In addition to process indication and control, the IO-Link variant enables diagnostic information and features additional functionality that is unique to ThinkTop.

If new functionality is implemented in ThinkTop V50, then a new IO-Link interface description is generated. Both the new and old IO-Link will be included in the revision of the "ThinkTop IO-Link zip-file".

It's recommended to just add them all to the preferred IO-Link configuration tool. The configuration tool will automatically match the correct IO-Link with the connected ThinkTop.

Device name	ThinkTop V50 IOL
IO-Link supply voltage	<ul style="list-style-type: none"> 24 VDC \pm 10%; according to EN 61131-2
Protection	<ul style="list-style-type: none"> Reverse polarity (24 VDC \pm 10%); EN 61131-2 Voltage interruption and brown-out; EN61131 Short circuit; EN 61131
Current consumption	<ul style="list-style-type: none"> Nominal: 30 mA (idle) Max 100 mA (solenoid valve and seat lift sensor active)
Terminal type	<ul style="list-style-type: none"> Spring force push-in technology Supports nominal wire cross-section between 1.0 mm² [17AWG] and 0.30 mm² [22AWG] Supports wire and ferrules for wire cross-section of 0.75 mm² [18AWG] with pin length 12 mm
ThinkTop control board revisions	<ul style="list-style-type: none"> The interface description "Before Dec. 2021" match ThinkTop control boards of revisions AA to AD The interface description marked "After Dec. 2021" match ThinkTop control boards of revision AE or later
Download of IO-Link files	<ul style="list-style-type: none"> Alfa Laval Anytime and ThinkTop configurator Go to www.alfalaval.com ThinkTop and documentation Go to www.io-link.com Click IO-Link finder and key ThinkTop
IO-Link interface tool	<ul style="list-style-type: none"> IFM E30390 IO-Link Interface / USB IO-Link master IFM LR Device – Line recorder
ThinkTop V50	<ul style="list-style-type: none"> "Before Dec. 2021" match Device ID 1 "After Dec. 2021" match Device ID 9
Cable length to IO-Link master	<ul style="list-style-type: none"> Max 20 meters
Transmission rate	<ul style="list-style-type: none"> COM 2 (38.4 kBaud)
Minimum cycle time	<ul style="list-style-type: none"> 5 ms
Data storage	<ul style="list-style-type: none"> yes
Profiles	<ul style="list-style-type: none"> na
SIO mode	<ul style="list-style-type: none"> no
Port class	<ul style="list-style-type: none"> A



IO-Link data table

For the IO-Link version, the bit assignment and diagnostic data can be found in the manual "IO-Link Interface Description" for ThinkTop V50 respectively. Go to www.alfalaval.com ThinkTop V and documentation

On ThinkTop V50 control board, using the IO-Link interface tool from IFM, all parameter settings and visualisation data are available through the diagnostic connection port

From the "IO-Link Interface Description" the table below shows an overview of the data storage parameters. When replacing a ThinkTop V-series on a process plant, some data are re-stored, included in the new ThinkTop V-series, and other data must be reassigned again, excluded in the new ThinkTop V-series.

Please note that data storage is a feature that must be actively selected in the PLC's hardware configuration when setting up the IO-link master.

Included	Excluded
Customization <ul style="list-style-type: none"> • Application Specific Tag • Error modifier timeout • Function Tag • Location Tag • Power save • Button lock • RGB colour • Seat valve pulse • Rotary valve pulse • USA bit mapping 	Control board ID <ul style="list-style-type: none"> • Vendor Name • Vendor Text • Product Name • Product ID • Product Text • Serial Number • Hardware Version • Firmware Version • Prod Date
	Setup data <ul style="list-style-type: none"> • Setup positions • Setup state
	Diagnostics <ul style="list-style-type: none"> • SV-activations • SV-ON_time • PV-SetupStrokeEn • PV-SetupStrokeDeEn • PressureShockCnt • Temp • Log

Electrical connections

ThinkTop V50

Terminal	Control board	Colour code wires
1	L +24V	BN (brown)
2	L -GND	BU (blue)
3	IO-Link signal	BK (black)

ThinkTop V50

M12 option (4-pin A-coded plug)

Pin numbers and terminal numbers are aligned

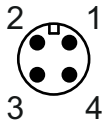
M12 Chassis plug connector	Control board Terminal numbers	M12 pin assignments wire colours
 20610004	1: L +	Pin 1: BN (brown)
	2: nc	-
	3: L -	Pin 3: BU (blue)
	4: Out1	Pin 4: BK (black)

This document and its contents are subject to copyrights and other intellectual property rights owned by Alfa Laval AB (publ) or any of its affiliates (jointly "Alfa Laval"). No part of this document may be copied, re-produced or transmitted in any form or by any means, or for any purpose, without Alfa Laval's prior express written permission. Information and services provided in this document are made as a benefit and service to the user, and no representations or warranties are made about the accuracy or suitability of this information and these services for any purpose. All rights are reserved.

How to contact Alfa Laval

Up-to-date Alfa Laval contact details for all countries are always available on our website at www.alfalaval.com