

ARTICULO: 2831

Junta de expansión de EPDM extremos Bridados DIN. Rubber Expansion Joint, DIN Flanged ends.

Características

1. Junta de expansión.
2. Reducción de Ruidos.
3. Absorción de Vibraciones.
4. Compensación de dilataciones.
5. Facil instalación.
6. Cuerpo de EPDM, Extremos acero carbono.
7. Extremos bridados según DIN 2501 PN 10.
8. Presión de trabajo máxima 10 bar.
9. Depresión máxima (vacío) 400 mm Hg.
10. Temperatura de Trabajo – 10 °C + 105 °C.

Features

1. Expansion Joint.
2. Reduction of Noise.
3. Absortion of vibration.
4. Allows axial and lateral movement.
5. Easy to install.
6. Body made of EPDM, Ends of carbon steel..
7. Flanged ends according to DIN 2501 PN 10.
8. Max. Working pressure 10 bar.
9. Max. Working Vacuum 400 mm Hg.
10. Working temperature – 10 °C + 105 °C.

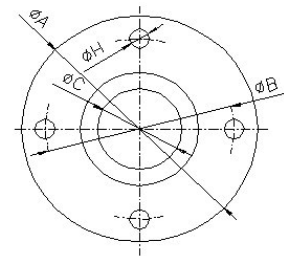
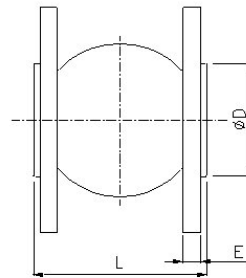
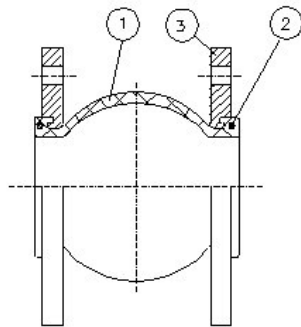

Nº	Denominación/Name	Material	Acabado Superficial/Surface Treatment
1	Cuerpo / Body	EPDM	-----
2	Aro / Ring	Acero Carbono / Carbon steel	Cincado / Zinc plated.
3	Brida / Flange	Acero Carbono / Carbon steel	Cincado / Zinc plated.

DIMENSIONES GENERALES / GENERAL DIMENSIONS

Ref	Medida/ Size	DN	PN	Dimensiones/Dimensions (mm)							Peso/Weight (Kg)
				ØA	ØB	ØC	ØD	n x ØH	L	E	
2831 07	1 1/4"	32	10	140	100	32	69	4 x 18	95	16	2.86
2831 08	1 1/2"	40	10	150	110	40	69	4 x 18	95	16	3.24
2831 09	2"	50	10	165	125	52	86	4 x 18	105	18	4.10
2831 10	2 1/2"	65	10	185	145	68	106	4 x 18	115	18	4.87
2831 11	3"	80	10	200	160	76	126	8 x 18	130	20	6.20
2831 12	4"	100	10	220	180	103	150	8 x 18	135	20	6.80

Ref	Medida/ Size	DN	PN	Dimensiones/Dimensions (mm)							Peso/Weight (Kg)
				ØA	ØB	ØC	ØD	n x ØH	L	E	
2831 13	5"	125	10	250	210	128	180	8 x 18	170	22	9.50
2831 14	6"	150	10	285	240	152	209	8 x 23	180	22	12.40
2831 16	8"	200	10	340	295	194	260	8 x 23	195	24	16.86
2831 18	10"	250	10	395	350	250	320	12x23	240	26	21.20
2831 20	12"	300	10	445	400	300	367	12x23	260	26	28.10
2831 22	14"	350	10	505	460	320	408	16x23	265	28	36.70
2831 24	16"	400	10	565	515	372	472	16x28	265	32	44.40
2831 26	18"	450	10	615	565	415	522	20x28	265	36	46.80
2831 28	20"	500	10	670	620	454	570	20x28	265	38	59.00

Diagrama de desplazamientos / Diagram of Displacement

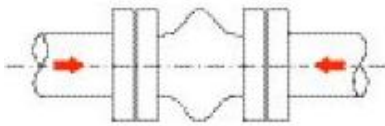

Compresión Axial / Axial Compression

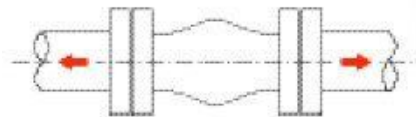

Elongación Axial / Axial Elongation

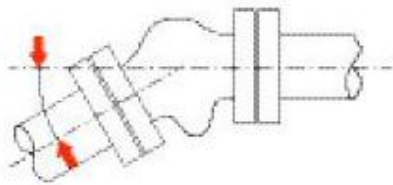

Deflexión Angular / Angular Deflection

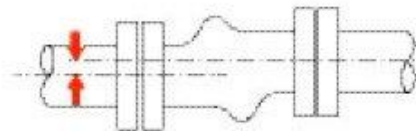

Desplazamiento Lateral / Lateral Displacement

Ref	Compresión axial / Axial compression	Elongación axial / Axial stretch	Deflexión angular / Angular deflection	Despl. Lateral / Lateral disp.
	m m .	m m .	$\alpha 1 + \alpha 2$	m m .
2831 07	20	12	15°	14
2831 08	20	12	15°	14
2831 09	20	12	15°	14
2831 10	20	12	15°	14
2831 11	20	12	15°	14
2831 12	20	12	15°	14
2831 13	20	12	15°	14
2831 14	20	12	15°	14
2831 16	20	12	15°	14
2831 18	20	12	15°	14
2831 20	25	16	15°	22
2831 22	25	16	15°	22
2831 24	25	16	15°	22
2831 26	25	16	15°	22
2831 28	25	16	15°	22